

FEATURES

- **Compact (half-size).**

The base area is approximately half the size of conventional (JS-M) relays. The controller unit can be made more compact.

Base area has been reduced by one half

- **Standard terminal pitch employed**

The terminal array used is identical to that used in small automotive relays.

- **Plastic sealed type.**

Plastically sealed for automatic cleaning.

- **Line-up of 1 Form A and 1 Form C.**

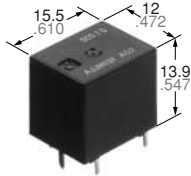

mm inch

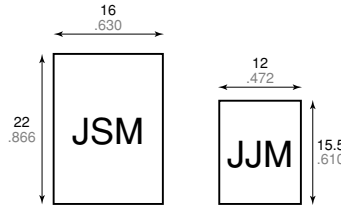

- **Perfect for automobile electrical systems.**

Over 2×10^5 openings possible with a 14 V DC motor load, an inrush current of 25 A, and steady state current of 5 A. (N.O. side)

TYPICAL APPLICATIONS

- Power windows
- Auto door lock
- Electrically powered sun roof
- Electrically powered mirror
- Cornering lamp, etc.

Compliance with RoHS Directive

SPECIFICATIONS

Contact			1 Form A		1 Form C	
Arrangement			1 Form A		1 Form C	
Contact material			Ag alloy (Cadmium free)			
Initial contact resistance (Initial) (By voltage drop 6V DC 1A)			Typ. 5 mΩ			
Rating (resistive load)	Nominal switching capacity		20 A 14 V DC	20 A 14 V DC (N.O.) 10 A 14 V DC (N.C.)		
	Min. switching capacity ^{#1}		1 A 12 V DC			
	Max. carrying current		N.O.: 35 A (12V, at 20°C 68°F for 2 minutes) 25 A (12V, at 20°C 68°F for 1 hour) 30 A (12V, at 85°C 185°F for 2 minutes) 20 A (12V, at 85°C 185°F for 1 hour)			
Expected life (min. operations)	Mechanical (at 120cpm)		10 ⁷			
	Electrical (at rated load)	Resistive	10 ⁵ * ₁	10 ⁵ (N.O.)* ₂ 10 ⁵ (N.C.)* ₃		
		Motor load	2×10 ⁵ * ₄ 5×10 ⁴ * ₅	2×10 ⁵ (N.O.)* ₆ 5×10 ⁴ (N.O.)* ₇ 2×10 ⁵ (N.C.)* ₈		
Coil			Nominal operating power 640 mW			

#1 This value can change due to the switching frequency, environmental conditions, and desired reliability level, therefore it is recommended to check this with the actual load.

Remarks

- *₁ at 20 A 14 V DC, at 20 cpm, operating frequency: 1s ON, 9s OFF
- *₂ at 20 A 14 V DC, operating frequency: 1s ON, 9s OFF
- *₃ at 10 A 14 V DC, at 20 cpm, operating frequency: 1s ON, 9s OFF
- *₄ at 5 A (steady), 25 A (inrush) 14 V DC
- *₅ at 20 A 14 V DC (Motor lock), operating frequency: 0.5 s ON, 9.5 s OFF
- *₆ at 5A (steady), 25 A (inrush) 14 V DC

Characteristics

Max. operating speed (at rated load)		6 cpm
Initial insulation resistance* ₉		Min. 100 MΩ (at 500 V DC)
Initial breakdown voltage* ₁₀	Between open contacts	500 Vrms for 1min.
	Between contact and coil	500 Vrms for 1min.
Operate time* ₁₁ (at nominal voltage)		Max. 10 ms (at 20°C 68°F)
Release time (without diode)* ₁₁ (at nominal voltage) (Initial)		Max. 10 ms (at 20°C 68°F)
Shock resistance	Functional* ₁₂	Min. 100 m/s ² {10 G}
	Destructive* ₁₃	Min. 1,000 m/s ² {100 G}
Vibration resistance	Functional* ₁₄	10 Hz to 100 Hz, Min. 44.1 m/s ² {4.5 G}
	Destructive	10 Hz to 500 Hz, Min. 44.1 m/s ² {4.5 G}
Conditions in case of operation, transport and storage* ₁₅ (Not freezing and condensing at low temperature)	Ambient temp.	-40°C to +85°C -40°F to +185°F
	Humidity	5% R.H. to 85% R.H.
Mass		Approx. 5 g .176 oz

*₇ at 20 A 14 V DC (Motor lock)

*₈ at peak 20 A 14 V DC (Braking current) operating frequency: 0.5 s ON, 9.5 s OFF

*₉ Measurement at same location as "Initial break down voltage" section.

*₁₀ Detection current: 10mA

*₁₁ Excluding contact bounce time.

*₁₂ Half-wave pulse of sine wave: 11 ms; detection time: 10 μs

*₁₃ Half-wave pulse of sine wave: 6 ms

*₁₄ Detection time: 10 μs

*₁₅ Refer to Conditions for operation, transport and storage mentioned in AMBIENT ENVIRONMENT
Please inquire if you will be using the relay in a high temperature atmosphere (110°C 230°F).

ORDERING INFORMATION

Ex. JJM

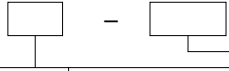

Contact arrangement	Coil voltage(DC)
1a: 1 Form A 1: 1 Form C	12 V

(Note) Standard packing: Carton: 50 pcs.; Case: 1,000 pcs.

TYPES AND COIL DATA (at 20°C 68°F)

Contact arrangement	Part No.	Nominal voltage, V DC	Pick-up voltage, V DC (Initial)	Drop-out voltage, V DC (Initial)	Coil resistance Ω	Nominal operating current mA	Nominal operating power mW	Usable voltage range, V DC
1 Form A	JJM1a-12 V	12	Max. 7.2	Min. 1.0	225±10%	53.3±10%	640	10 to 16
1 Form C	JJM1-12 V	12	Max. 7.2	Min. 1.0	225±10%	53.3±10%	640	10 to 16

* Other pick-up voltage types are also available. Please contact us for details.

DIMENSIONS

mm inch

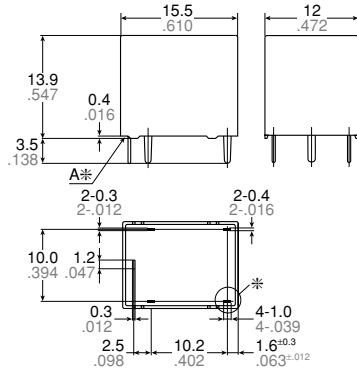

Note: *Marked terminal is only for 1Form C type

* Dimensions (thickness and width) of terminal specified in this catalog is measured before pre-soldering. Intervals between terminals is measured at A surface level.

Schematic (Bottom view)

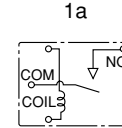

1c

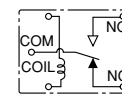

PC board pattern (Bottom view)

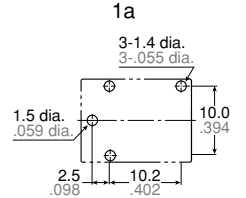

1c

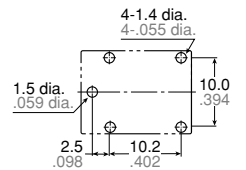

Tolerance: ±0.1 ±.004

Dimension:	General tolerance
Max. 1mm .039 inch:	±0.1 ±.004
1 to 3mm .039 to .118 inch:	±0.2 ±.008
Min. 3mm .118 inch:	±0.3 ±.012

REFERENCE DATA

1. Coil temperature rise

Sample: JJM1-12V, 6pcs
Point measured: Inside the coil
Contact current: Now current through contact, 5A, 10A, 15A, 20A
Resistance method, ambient temperature 85°C 185°F

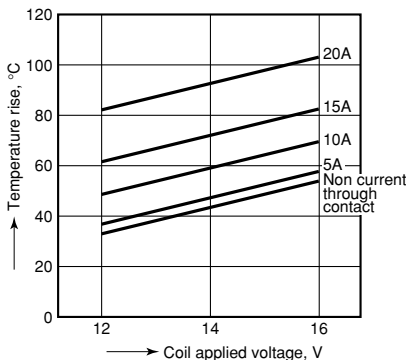

2. Max. switching capability (Resistive load)

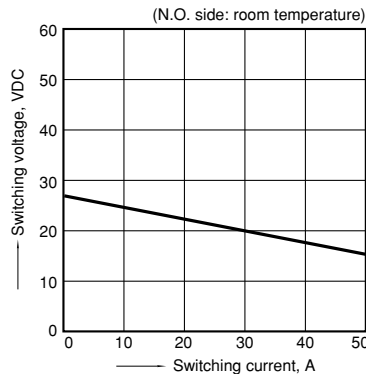

3. Ambient temperature and operating voltage range

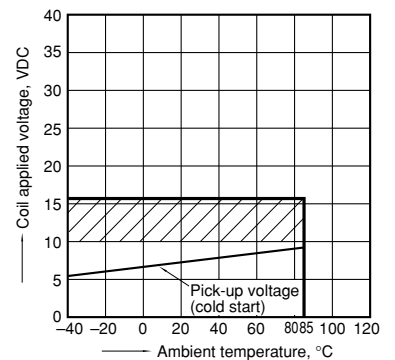

JJ-M

4. Distribution of pick-up and drop-out voltage

Sample: JJM1-12V, 100pcs

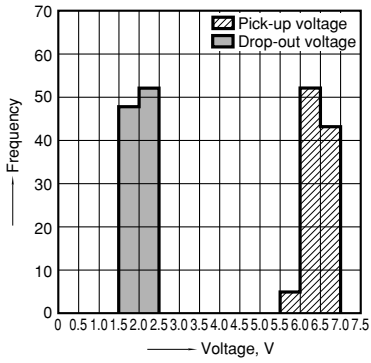

5. Distribution of operate time

Sample: JJM1-12V, 100pcs

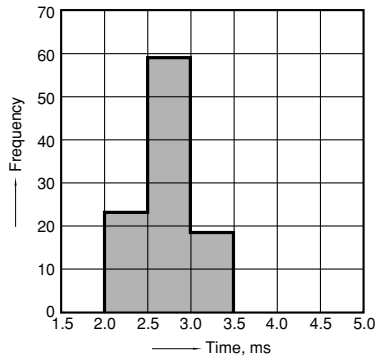

6. Distribution of release time

Sample: JJM1-12V, 100pcs
* With diode

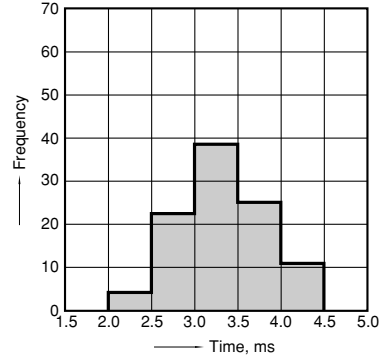

7-(1). Electrical life test (at rated load)

Sample: JJM1-12V
Quantity: n = 6 (NC = 3, NO = 3)
Load: Resistive load (NC side: 10A 14V DC, NO side: 20 A 14 V DC); Operating frequency: ON 1s, OFF 9s
Ambient temperature: Room temperature

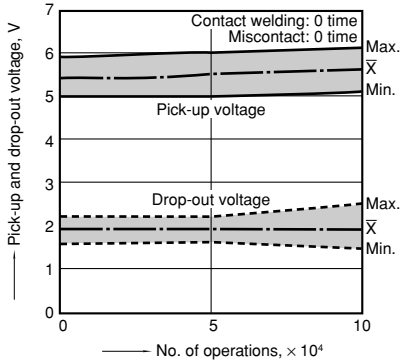

7-(2). Electrical life test (Motor free)

Sample: JJM1-12V, 6pcs.
Load: 5A, Inrush 25A, Brake current 18A 14V DC, Power window motor load (Free condition).
Operating frequency: (ON : OFF = 0.5s : 9.5s)
Ambient temperature: Room temperature

Circuit :

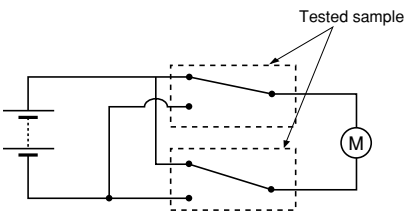

Change of pick-up and drop-out voltage

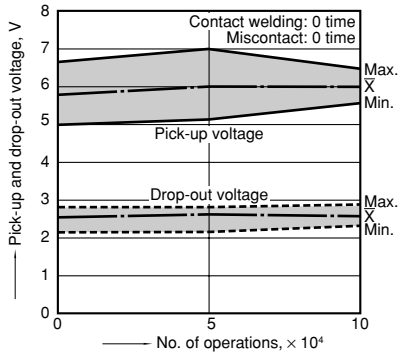

Change of contact resistance

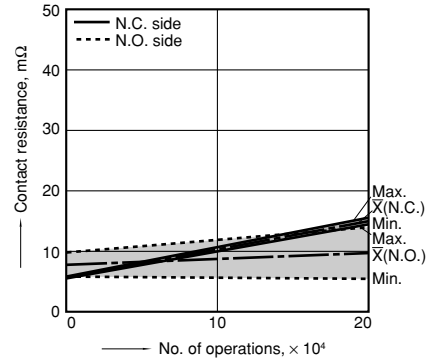

7-(3). Electrical life test (Motor lock)

Sample: JJM1-12V, 6pcs.
Load: 20A, 14VDC, Power window motor actual load (lock condition).
Operating frequency: (ON : OFF = 1s : 5s)
Ambient temperature: Room temperature

Circuit :

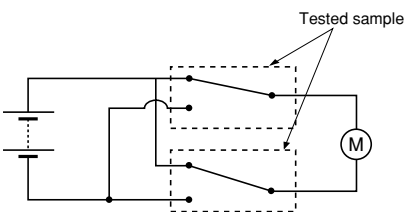

Change of pick-up and drop-out voltage

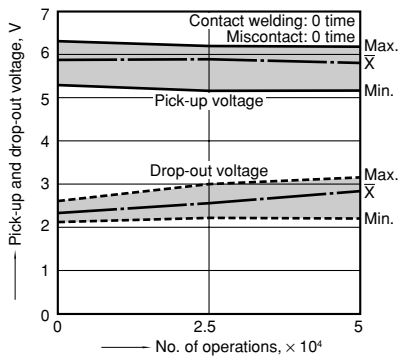

Change of contact resistance

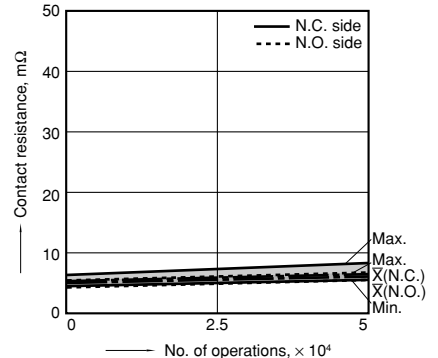

7-(4). Electrical life test (Lamp load)

Sample: JJM1-12V, 6pcs.
 Load: 27W+21W, min. 4A (steady), Lamp actual load
 Operating frequency: ON 2s, OFF 13s
 Ambient temperature: Room temperature

Circuit :

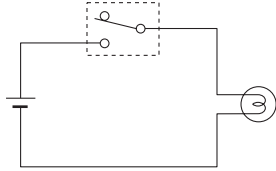

Inrush current: 42A, Steady current: 4.4A

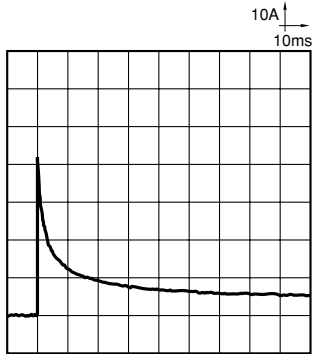

Change of pick-up and drop-out voltage

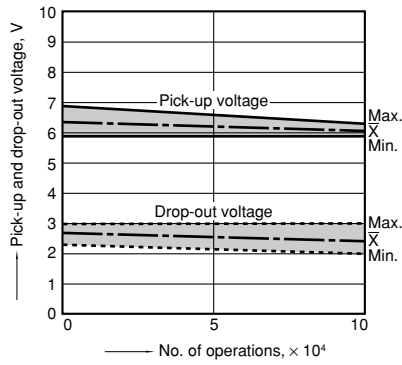

Change of contact resistance

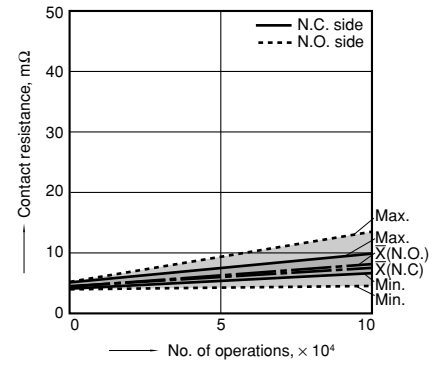

For Cautions for Use, see Relay Technical Information .